

8) a) TCA GAA GA  
 tem o padrão pedido  
 (é reconhecido)

b) O determinístico no pior caso  
 teria  $8!$  estados

c) É regular pois é reconhecido

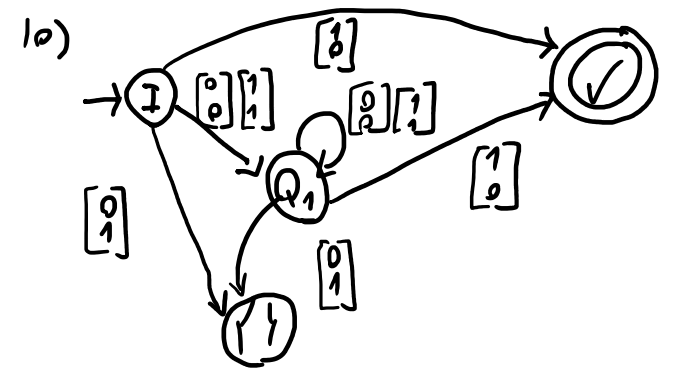
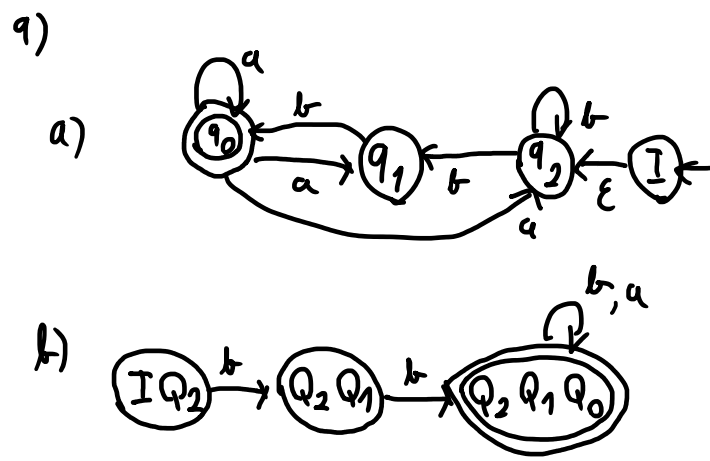
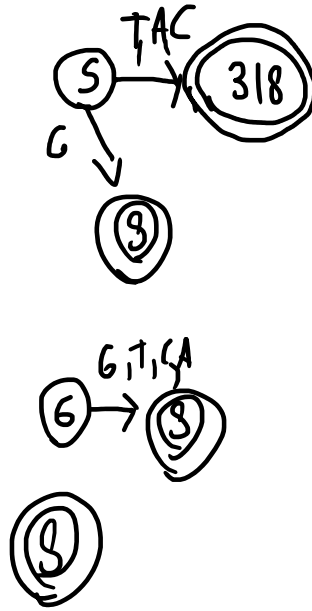
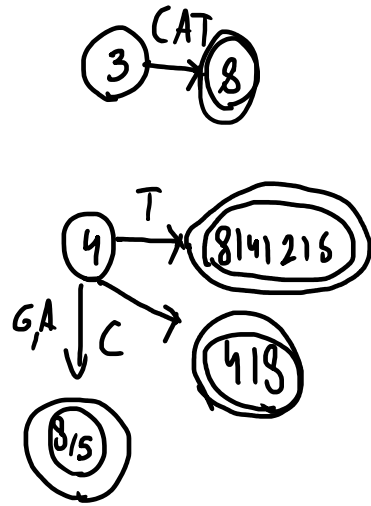
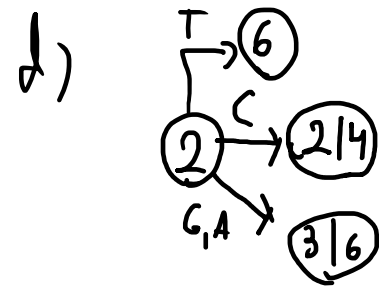
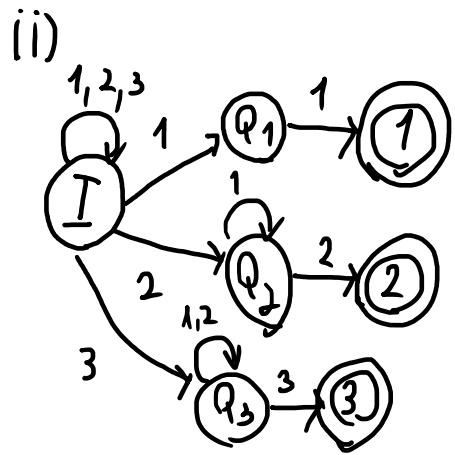

11) NOS SLIDES DA UC

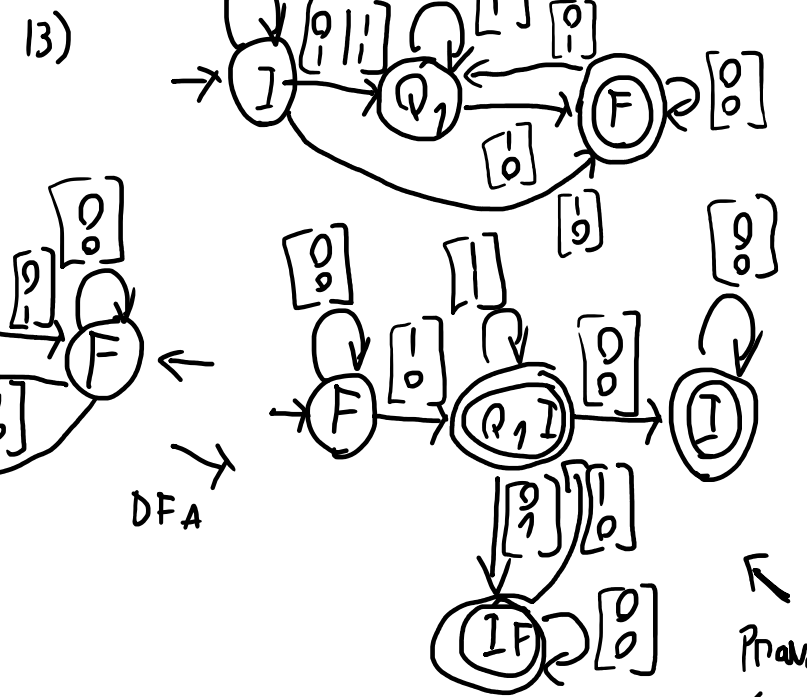
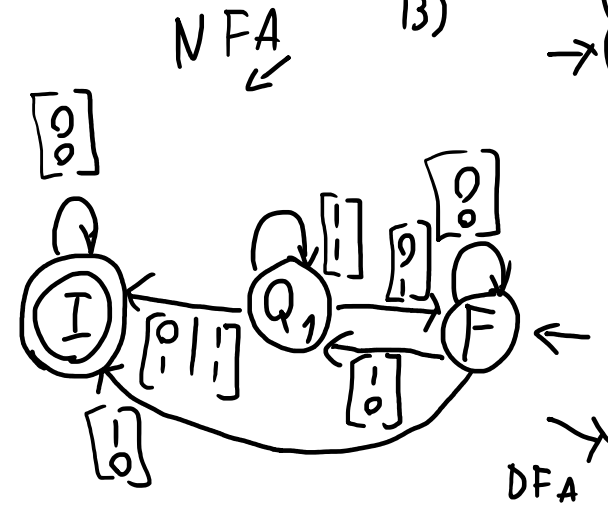
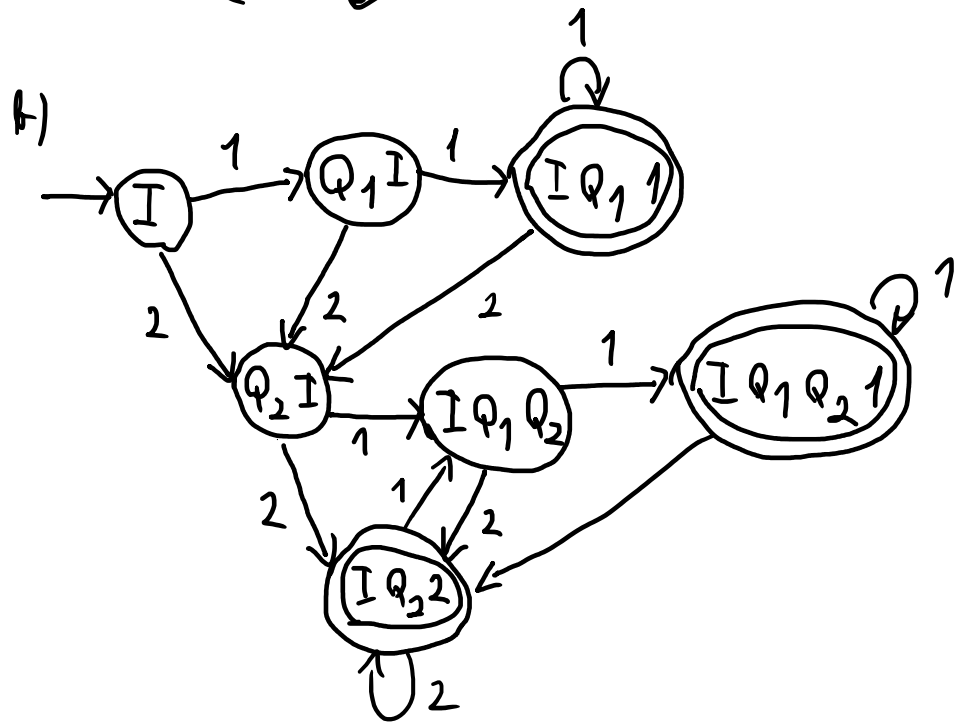
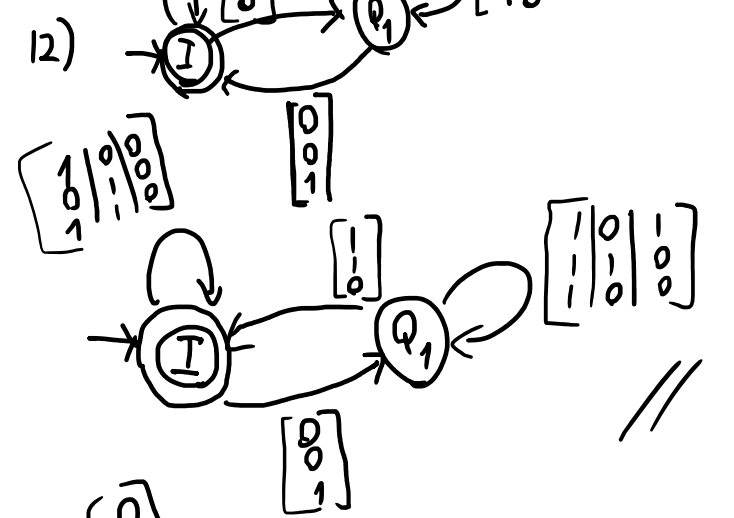
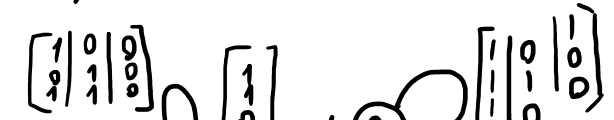

Prova  
 que é regular

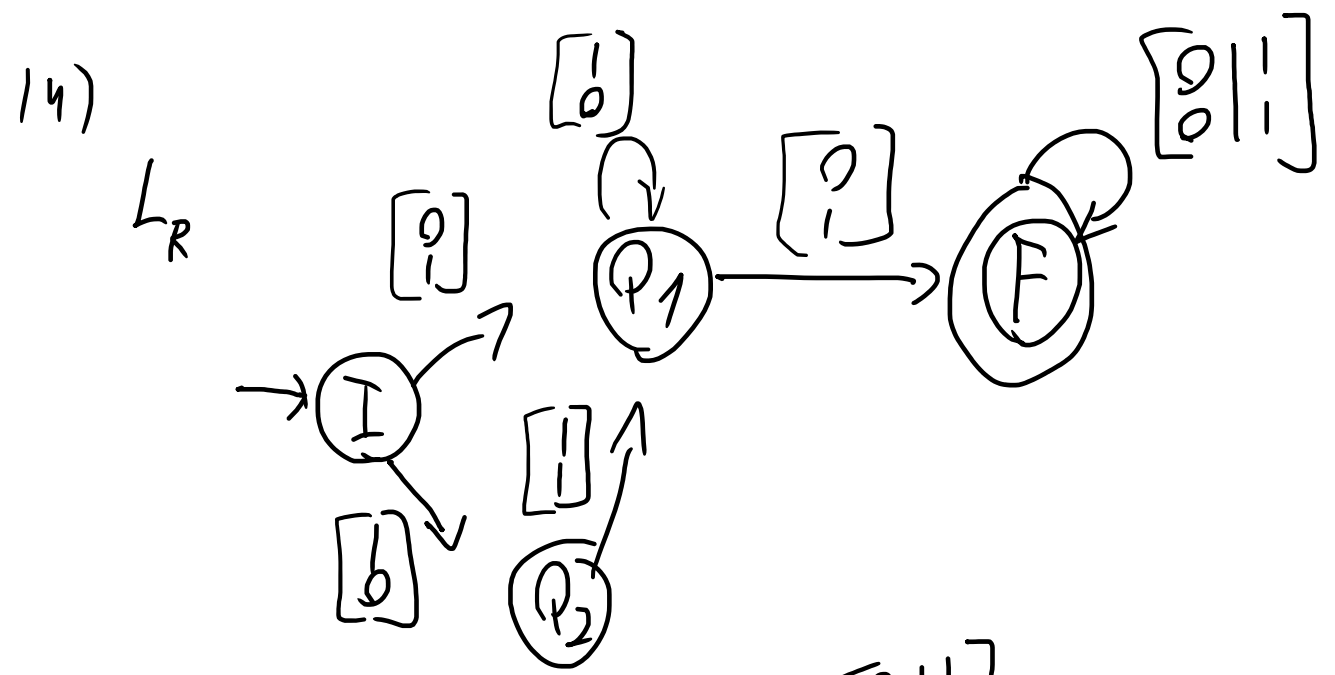

NFA ↓  
 Para i  
 Logo o DFA  
 que mostra  
 que é regular

